

ALLARME
INCENDIO

Wood coverings

**SHERWOOD
COVERING
500 - 501 - 502**
system

 **CBI**
EUROPE
HI-TECH INTERIORS

WOOD COVERING 500 SYSTEM



EASY INSPECT



CUSTOM SIZE

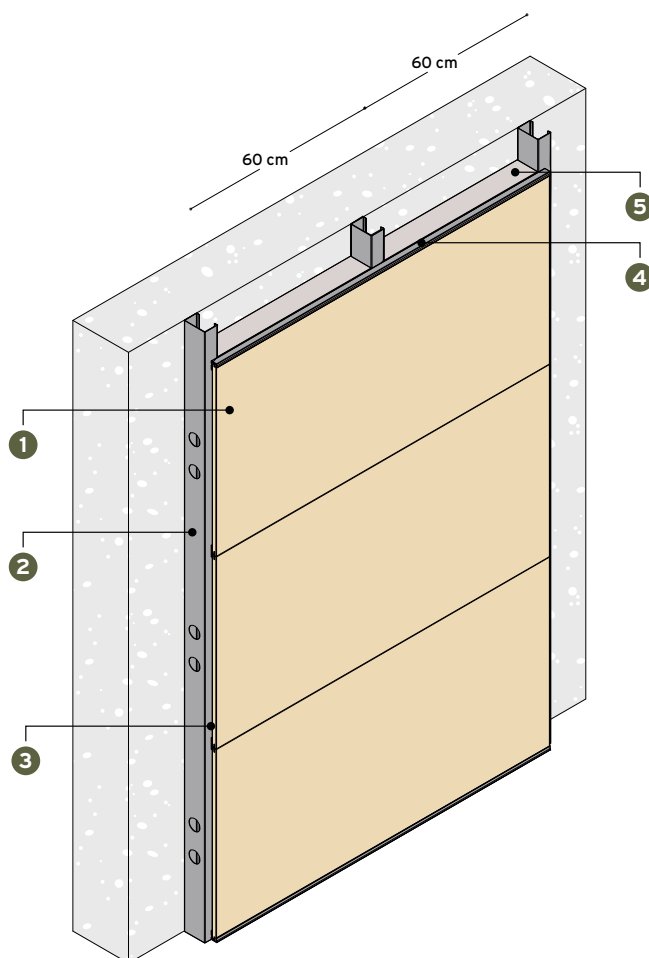

PANEL PANNELLO

dimension type
 square quadrato · SHERWOOD MELAMINE
 rectangular rettangolare · SHERWOOD REAL VENEER

custom su misura

GRID SYSTEM STRUTTURA

· WC1

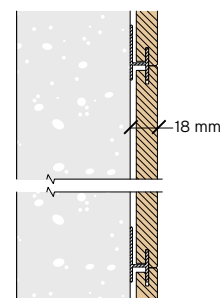
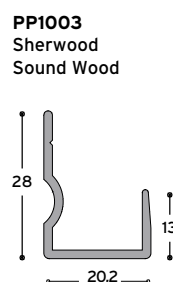
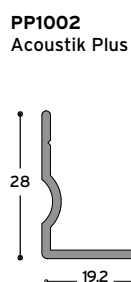
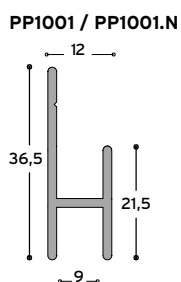

1

2

3

4

5

panel pannello	M46 / 75	primary support structure struttura di sostegno primaria	PP1001 Acoustik Plus Sherwood PP1001.N Sound Wood	secondary profile profilo secondario	PP1002 Acoustik Plus PP1003 Sherwood Sound Wood	starting profile profilo di partenza	PPN1 / 40.1 rockwool insulation lana di roccia 600 x 1200 mm
-------------------	-----------------	---	---	---	---	---	--

WOOD COVERING 501 SYSTEM



EASY INSPECT



CUSTOM SIZE

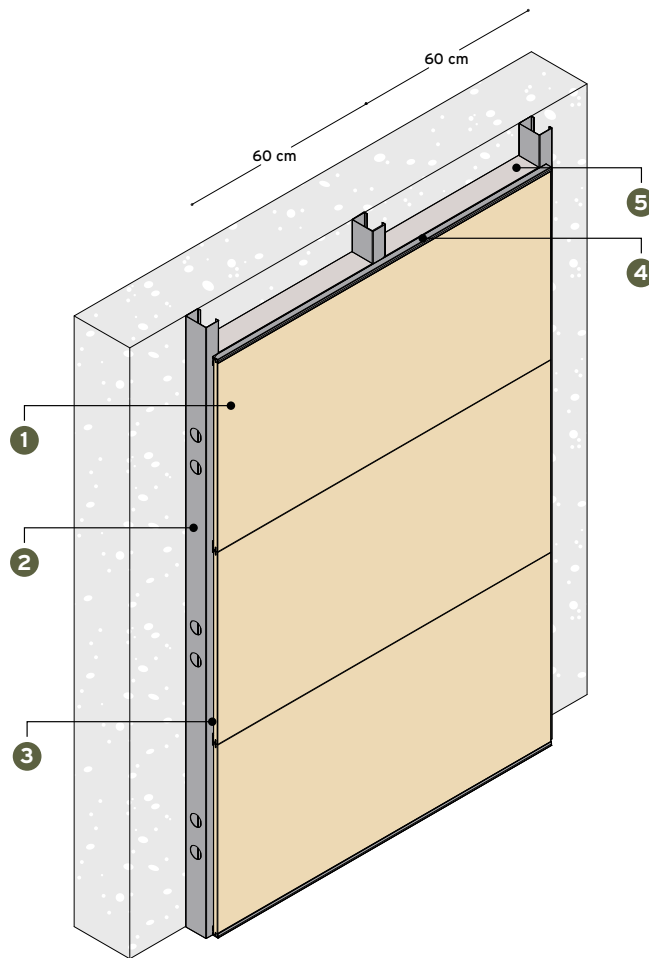

PANEL PANNELLO

dimension type
 square quadrato · SHERWOOD MELAMINE
 rectangular rettangolare · SHERWOOD REAL VENEER

custom su misura

GRID SYSTEM STRUTTURA

· WC6

PP1006

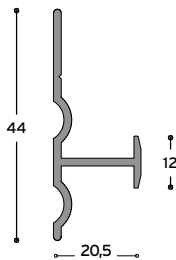

PP1002
Acoustik Plus

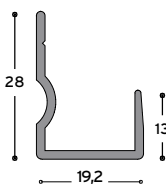

PP1003
Sherwood
Sound Wood

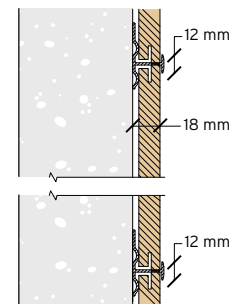
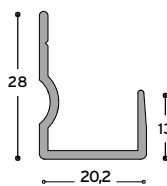

1

panel
pannello

2

M46 / 75 primary support
structure
struttura di sostegno
primaria

3

PP1006 secondary profile
profilo secondario

4

PP1002 Acoustik Plus
PP1003 Sherwood
Sound Wood starting profile
profilo di partenza

5

PPN1 / 40.1 rockwool insulation
lana di roccia
600 x 1200 mm

WOOD COVERING 502 SYSTEM



EASY INSPECT



CUSTOM SIZE

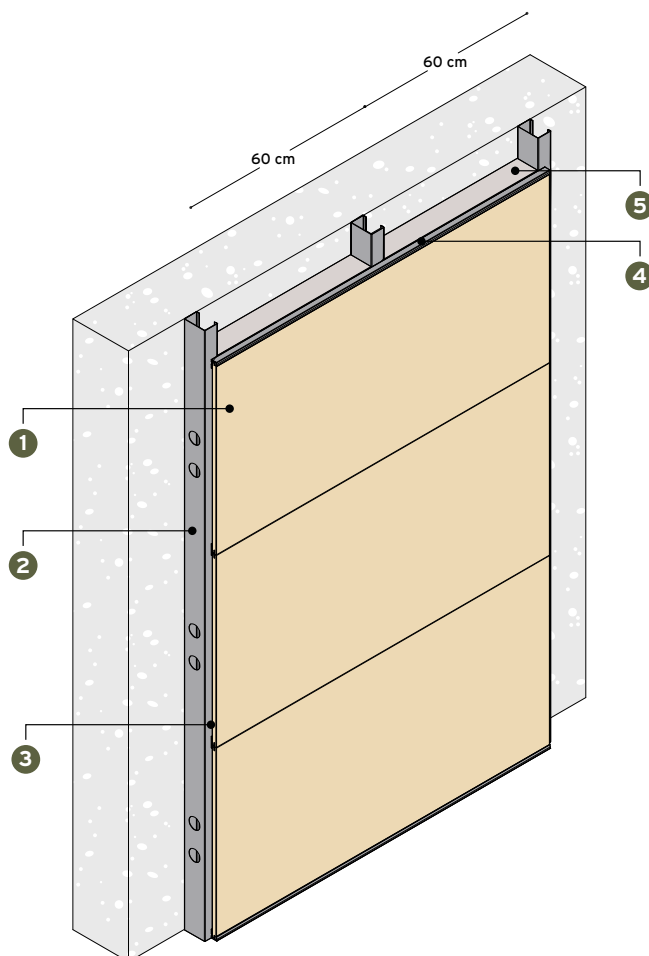

PANEL PANNELLO

dimension	type
square quadrato	· SHERWOOD MELAMINE
rectangular rettangolare	· SHERWOOD REAL VENEER

custom su misura

GRID SYSTEM STRUTTURA

· WC7

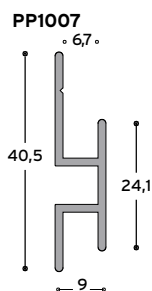

PP1002
Acoustik Plus

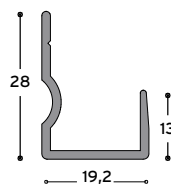

PP1003
Sherwood
Sound Wood

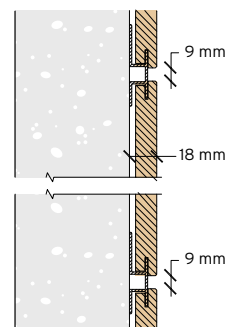
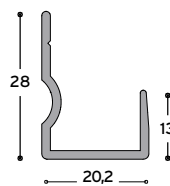

1

2

3

4

5

panel pannello	M46 / 75	primary support structure struttura di sostegno primaria	PP1007	secondary profile profilo secondario	PP1002 Acoustik Plus PP1003 Sherwood Sound Wood	starting profile profilo di partenza	PPN1 / 40.1	rockwool insulation lana di roccia 600 x 1200 mm
-------------------	-----------------	---	---------------	---	---	---	--------------------	--

TYPE OF PANELS

SHERWOOD · MDF HIGH DENSITY

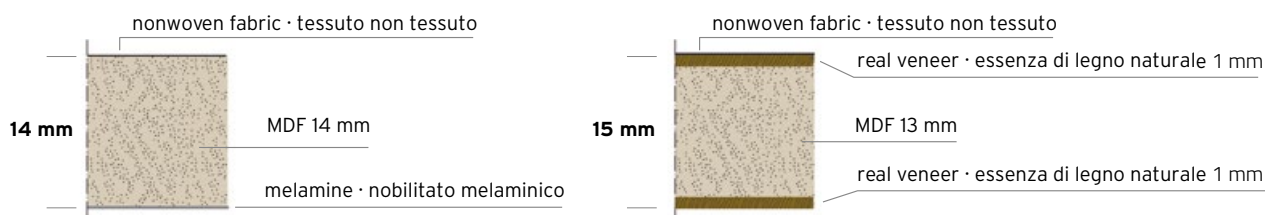

MDF HIGH DENSITY

Internal bond · Resistenza allo strappo	EN 319	0,65 / 1,1 N/mm ²
C.R.F.	EN 310	22 / 35,1 N/mm ²
M.O.E.	EN 310	2500 3180 N/mm ²
Thickness swelling 24H (max) · Rigonfiamento 24H (max)	EN 317	15,0 / 12,3 %
Surface soundness · Strappo superficiale	EN 311	1,2 / 1,8 N/mm ²
MDF Density · Densità	EN 323	780 Kg/m ³ +/- 5%
Thickness Tolerance · Tolleranza di spessore	EN 324-1	+/- 0,2 mm
Length and width tolerance · Tolleranza lunghezza e larghezza	EN 324-1	+/- 0,3 mm
Squareness · Squadro	EN 324-2	+/- 0,3 mm
Moisture content · Umidità	EN 322	4% - 11%
Grit content · Contenuto in silice	ISO 3340	< 0,05%
Formaldehyde · Formaldeide	EN 120	< 9 mg / 100 g
Fire reaction class · Classe di reazione al fuoco		B s₂ d₀

SHERWOOD · MULTILAYERS

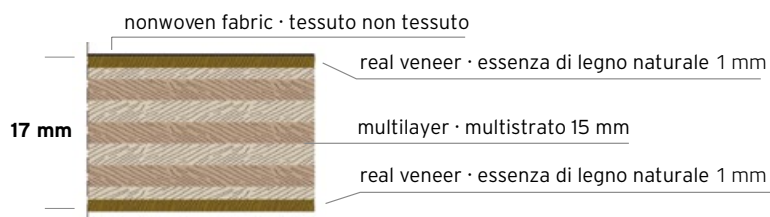

MULTILAYERS

Thickness · Spessore	EN 315	15 mm
Layers · Strati	EN 315	n° 7
Mass · Massa volumica	EN 323	Kg/m ³ 410 +/- 10%
Resistance to bending · Resistenza alla flessione		
Longitudinal · Longitudinale	EN 310	25 N/mm ²
Transversal · Trasversale	EN 310	25 N/mm ²
Thermal conductivity · Conduttività termica	EN 10456	W/m K 0,12
Moisture content · Umidità	EN 322	% 8 - 12
Formaldehyde · Formaldeide		E1
Fire reaction class · Classe di reazione al fuoco		
Standard	ISO 13986	Dfl s1
On demand · A richiesta	EN 13501-1	B s ₂ d ₀

MODULARITY

WALL CLADDINGS

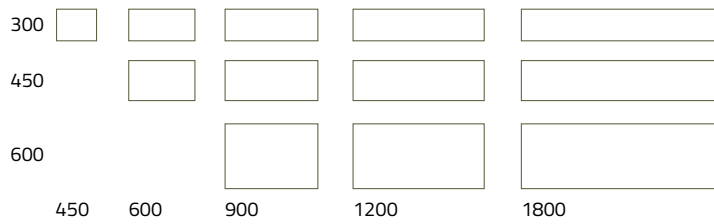

OTHER DIMENSION AVAILABLE ON REQUEST

sample compositions

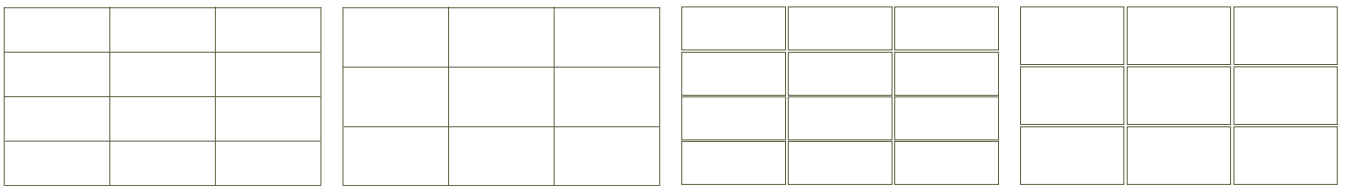

PERIMETRAL MOLDING

WOOD COVERING 500 / 501 / 502 SYSTEM

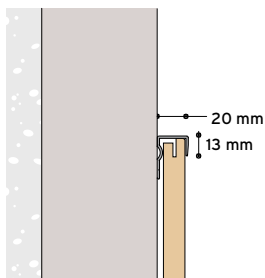

WC1 - WC2 - WC6 - WC7
PP1002 - PP1003

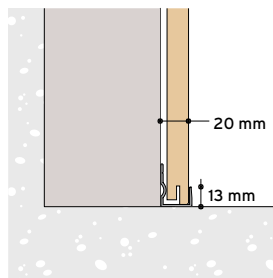

WC1 - WC2 - WC6 - WC7
PP1002 - PP1003

ACCESSORIES

AIR VENTS



H05



H06



H07



H08

REMOVABLE MANHOLE

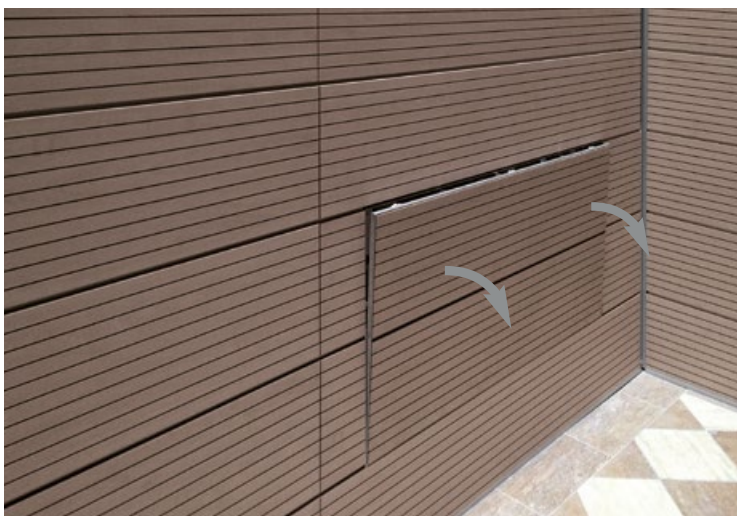

EASY INSPECT

The manhole is manufactured by CBI Europe measures on request.

FITTINGS

All Wood System panels permit the installation of fittings such as lighting, air nozzles, fume detectors, sprinklers and suspended signboards.

CORNERS

INTERNAL CORNER

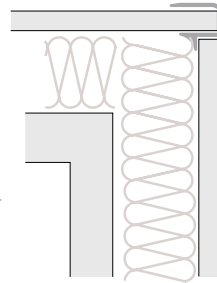
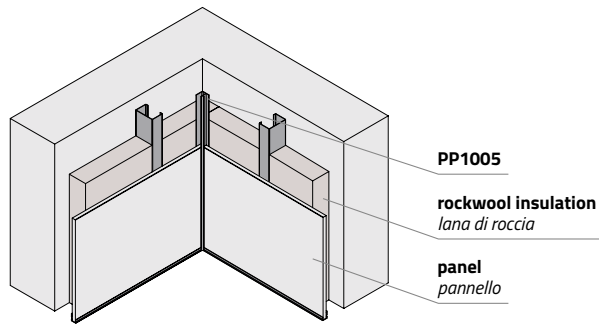

**PP1005
SHERWOOD**

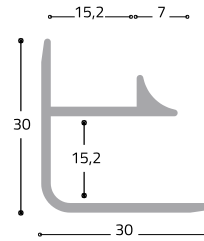

EXTERNAL CORNER

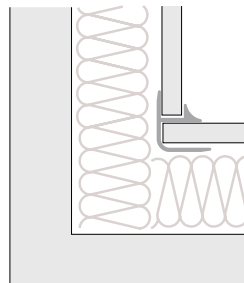
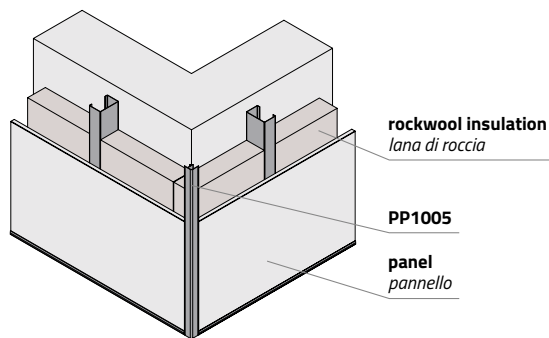

**PP1005
SHERWOOD**

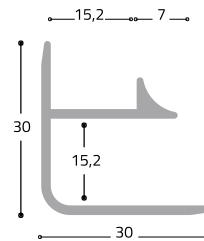

WOODEN CORNER

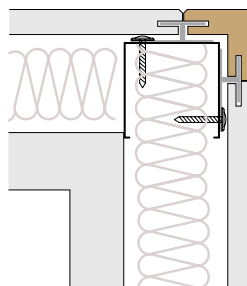
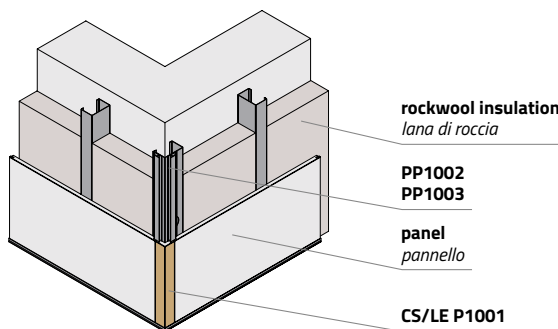

CS/LE P1001

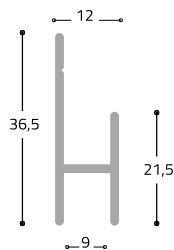

PROFILES

LINEAR PROFILE

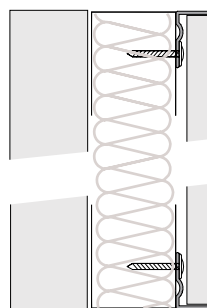
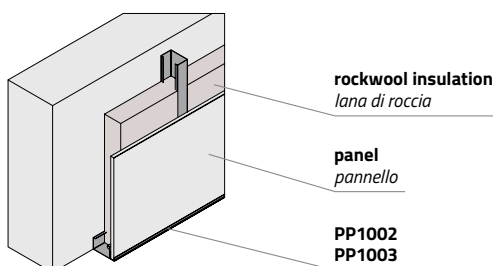

**PP1003
SHERWOOD**

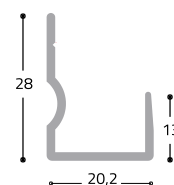

FINISHES

MELAMINE

> SHERWOOD



oak rock white



elm tafira



oak italia



oak bruges



walnut athens

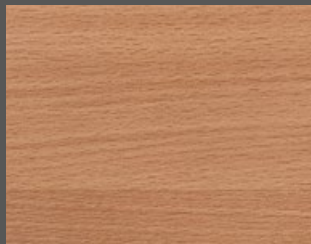

bavaria beech



white

REAL VENEER

> SHERWOOD



maple



wengè



beech



cherry



zebrano



ash tree



walnut 1

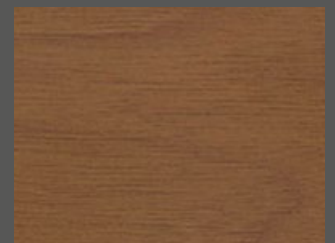

walnut 2



mahogany

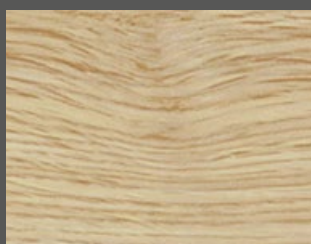

oak

The colour card shown on this page is purely for information purposes; please request samples. Please contact CBI Europe's Technical Office for special colour re-

quirements which will be supplied only for orders of at least 800 sq.m. Wood system accessories are finished in aluminium or wood.

PERFORATION



ACOUSTIC ABSORPTION

- no perforation
- perforation
- perforation
- slots

ABC = SHERWOOD PANELS



F00

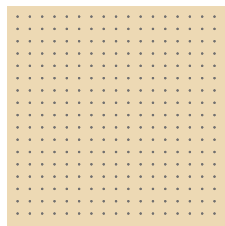

F01

Ø 6 = 2.27 %
Ø 8 = 4.03 %

● : 289

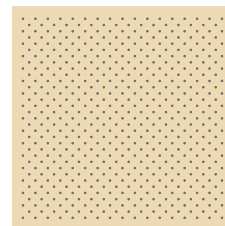

F02

Ø 6 = 4.28 %
Ø 8 = 7.61 %

● : 545

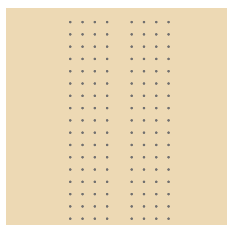

F03

Ø 6 = 1.07 %
Ø 8 = 1.90 %

● : 136

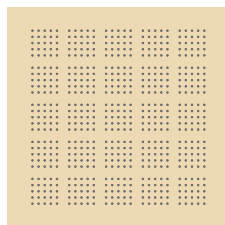

F04

Ø 6 = 4.28 %
Ø 8 = 7.61 %

● : 545

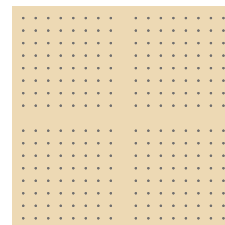

F05

Ø 6 = 2.01 %
Ø 8 = 3.57 %

● : 256

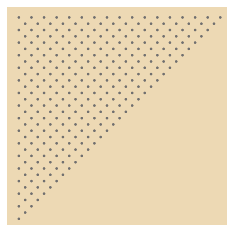

F06

Ø 6 = 1.20 %
Ø 8 = 2.14 %

● : 153

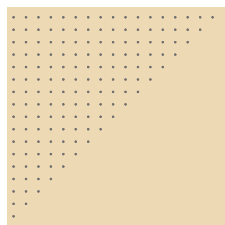

F07

Ø 6 = 2.27 %
Ø 8 = 4.03 %

● : 289

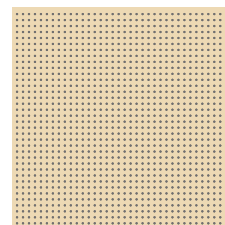

F08

Ø 6 = 10.17 %
Ø 8 = 18.09 %

● : 1296

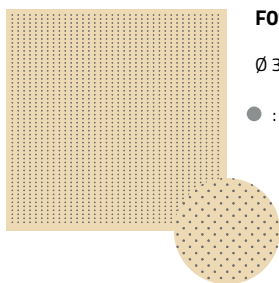

F09

Ø 3 = 2.55 %

● : 1296

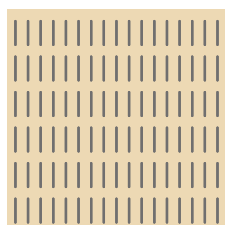

A01

6x66 mm - 11.00 %
8x66 mm - 14.57 %

▬ : 102

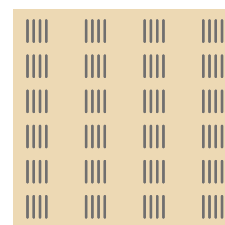

A02

6x60 mm - 9.39 %
8x60 mm - 12.43 %

▬ : 96

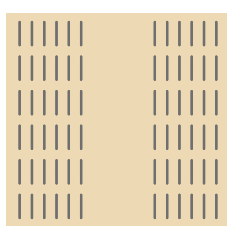

A03

6x66 mm - 10.35 %
8x66 mm - 13.71 %

▬ : 96

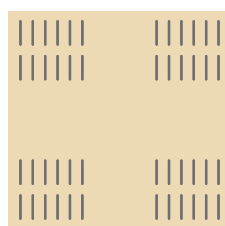

A04

6x66 mm - 5.18 %
8x66 mm - 6.86 %

▬ : 48

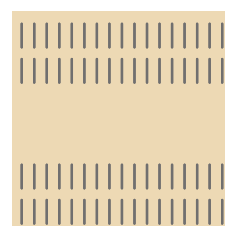

A05

6x66 mm - 7.33 %
8x66 mm - 9.71 %

▬ : 68

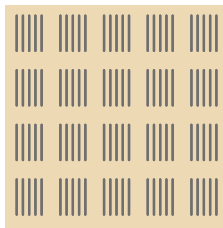

A06
6x96 mm - 15.79 %
8x96 mm - 20.95 %
: 100

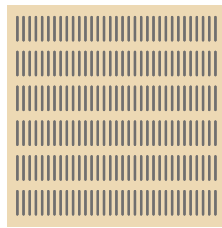

A07
6x60 mm - 19.37 %
8x60 mm - 25.64 %
: 198

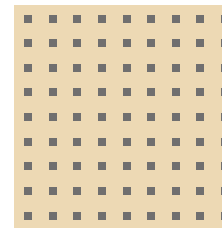

A08
20x20 mm = 9.00 %
: 81

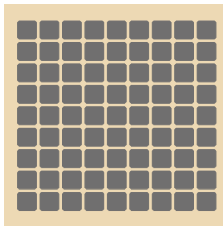

A09
50x50 mm = 56.25 %
: 81

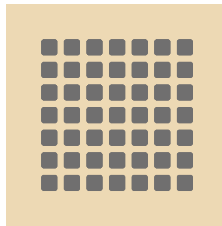

A10
40x40 mm = 21.77 %
: 81



A11
spacing larghezza 3 mm
depth profondità 2 mm
30 mm

ABC = SHERWOOD

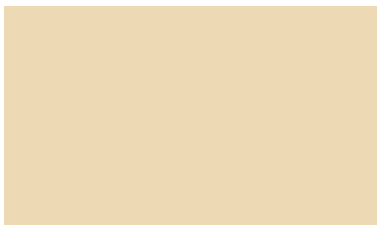

F00
280 x 1200 mm
280 x 1500 mm
280 x 1800 x 14 mm
280 x 2100 x 14 mm

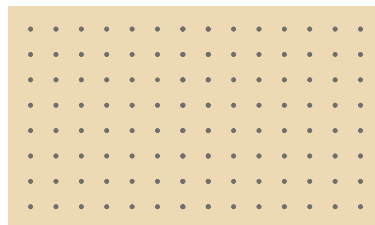

F01
Ø 6 Ø 8
2.49% | 4.43% | 280 x 1200 mm ● : 296
2.48% | 4.40% | 280 x 1500 mm ● : 368
2.47% | 4.39% | 280 x 1800 mm ● : 440
2.50% | 4.44% | 280 x 2100 mm ● : 520

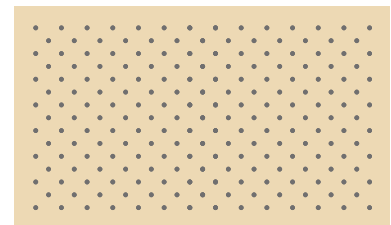

F02
Ø 6 Ø 8
4.61% | 8.19% | 280 x 1200 mm ● : 548
4.60% | 8.17% | 280 x 1500 mm ● : 683
4.63% | 8.22% | 280 x 1800 mm ● : 825
4.65% | 8.27% | 280 x 2100 mm ● : 968

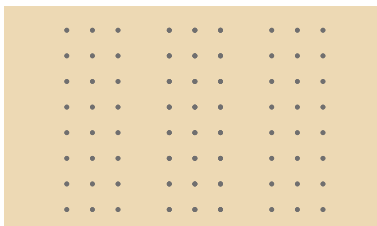

F03
Ø 6 Ø 8
1.82% | 3.23% | 280 x 1200 mm ● : 216
1.94% | 3.45% | 280 x 1500 mm ● : 288
1.88% | 3.35% | 280 x 1800 mm ● : 336
1.85% | 3.28% | 280 x 2100 mm ● : 384

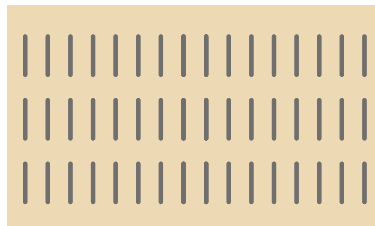

A01
6x66 8x66 mm
12.83% | 16.99% | 280 x 1200 mm : 111
12.76% | 16.90% | 280 x 1500 mm : 138
12.71% | 16.84% | 280 x 1800 mm : 165
12.88% | 17.05% | 280 x 2100 mm : 195

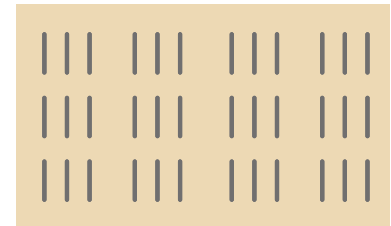

A02
6x66 8x66 mm
9.36% | 12.40% | 280 x 1200 mm : 81
9.98% | 13.22% | 280 x 1500 mm : 108
9.71% | 12.86% | 280 x 1800 mm : 126
9.51% | 12.59% | 280 x 2100 mm : 144



ACOUSTIC ABSORPTION PANELS

Giordano Institute n° 196088
197140 UNI EN ISO 354: 2003

— ceiling
— covering

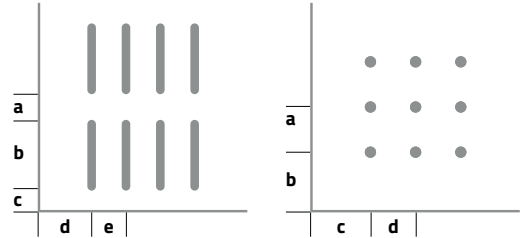

SLOTS

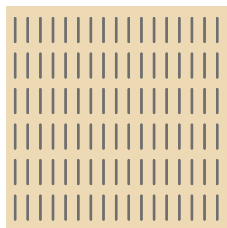

a = 32 mm
b = 58 mm
c = 46 mm
d = 44 mm
e = 32 mm
 $\emptyset 6 = 1.07\%$
 $\emptyset 8 = 1.90\%$

α_p 0,87 | 1,05 | 0,73 | 0,52 | 0,35 | $\alpha_{w0} = 0,50$
0,8 | 0,81 | 0,69 | 0,47 | 0,34 | $\alpha_{w0} = 0,50$

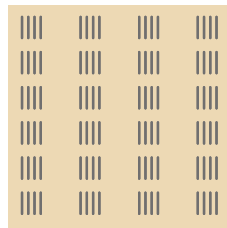
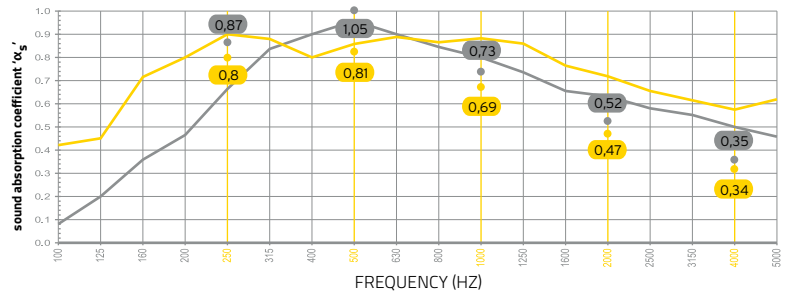

a = 38 mm
b = 52 mm
c = 49 mm
d = 51 mm
e = 16 mm

α_p 0,97 | 0,93 | 0,64 | 0,45 | 0,35 | $\alpha_{w0} = 0,50$
0,77 | 0,78 | 0,62 | 0,41 | 0,39 | $\alpha_{w0} = 0,45$

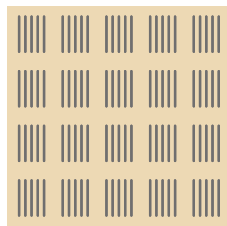
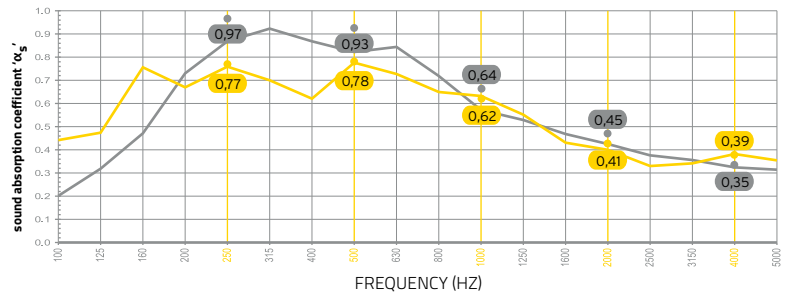

a = 52 mm
b = 88 mm
c = 46 mm
d = 44 mm
e = 16 mm

α_p 0,84 | 1,09 | 0,81 | 0,6 | 0,47 | $\alpha_{w0} = 0,60$
0,89 | 0,84 | 0,83 | 0,6 | 0,55 | $\alpha_{w0} = 0,50$

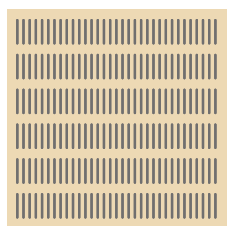
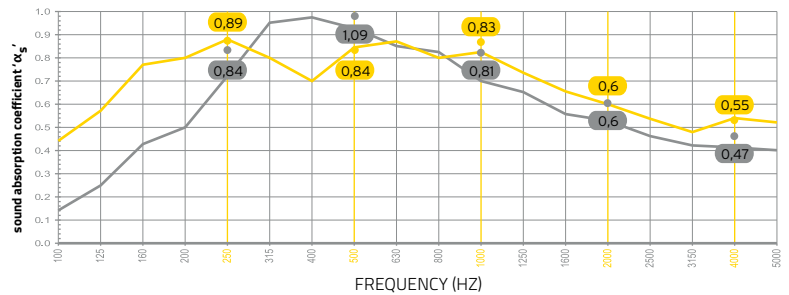

a = 32 mm
b = 58 mm
c = 46 mm
d = 44 mm
e = 16 mm

α_p 0,79 | 1,14 | 0,94 | 0,76 | 0,59 | $\alpha_{w0} = 0,75$
0,91 | 0,86 | 0,88 | 0,71 | 0,59 | $\alpha_{w0} = 0,75$

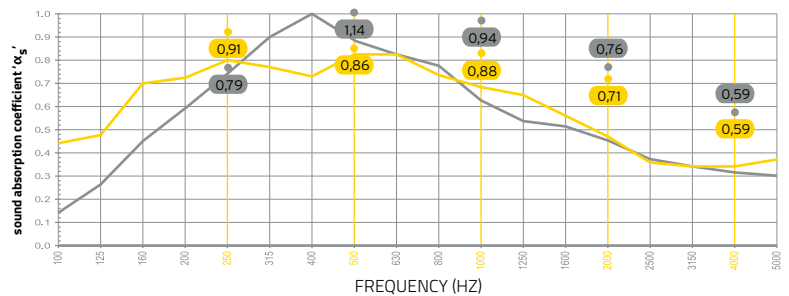

SMOOTH

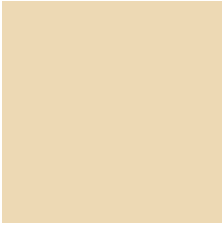

α_p 0,13 | 0,09 | 0,03 | 0,05 | 0,05 | $\alpha_w = 0,10$
0,06 | 0,07 | 0,05 | 0,02 | 0,02 | $\alpha_w = 0,05$

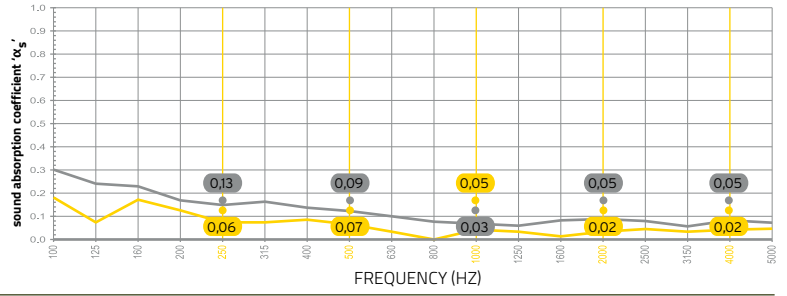

PERFORATION

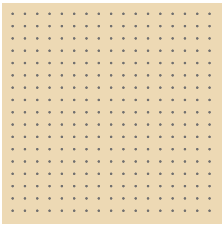

a = 32 mm
b = 44 mm
c = 44 mm
d = 32 mm

α_p 1,01 | 0,64 | 0,32 | 0,18 | 0,1 | $\alpha_w = 0,20$
0,67 | 0,57 | 0,3 | 0,15 | 0,13 | $\alpha_w = 0,25$

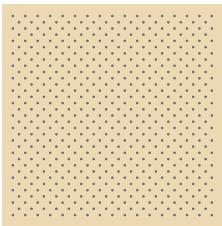
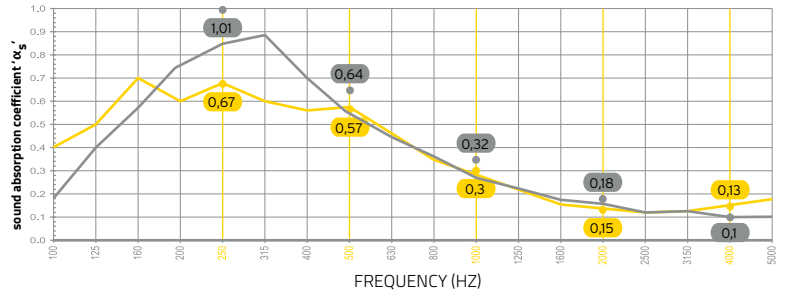

a = 16 mm
b = 44 mm
c = 44 mm
d = 16 mm

α_p 0,99 | 0,94 | 0,55 | 0,32 | 0,2 | $\alpha_w = 0,35$
0,8 | 0,78 | 0,54 | 0,29 | 0,19 | $\alpha_w = 0,35$

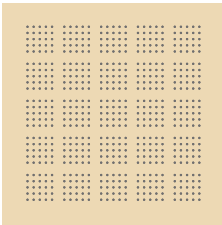
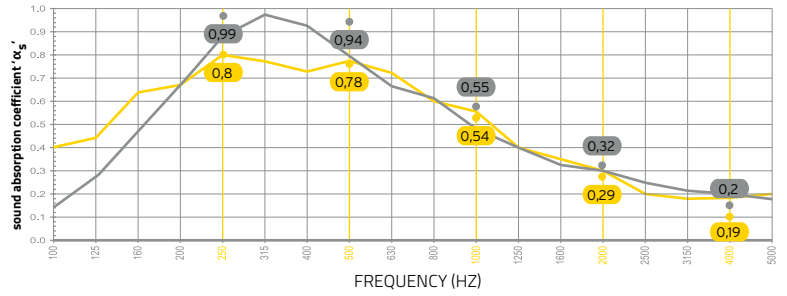

a = 16 mm
b = 76 mm
c = 76 mm
d = 16 mm

α_p 1 | 0,88 | 0,59 | 0,37 | 0,2 | $\alpha_w = 0,35$
0,75 | 0,75 | 0,55 | 0,32 | 0,24 | $\alpha_w = 0,35$

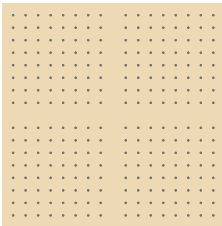
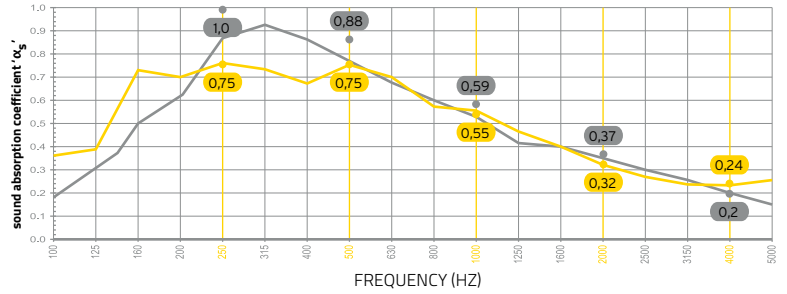

a = 32 mm
b = 44 mm
c = 44 mm
d = 32 mm

α_p 0,98 | 0,59 | 0,28 | 0,16 | 0,09 | $\alpha_w = 0,20$
0,61 | 0,56 | 0,3 | 0,16 | 0,15 | $\alpha_w = 0,25$

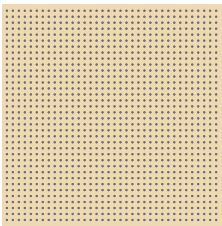
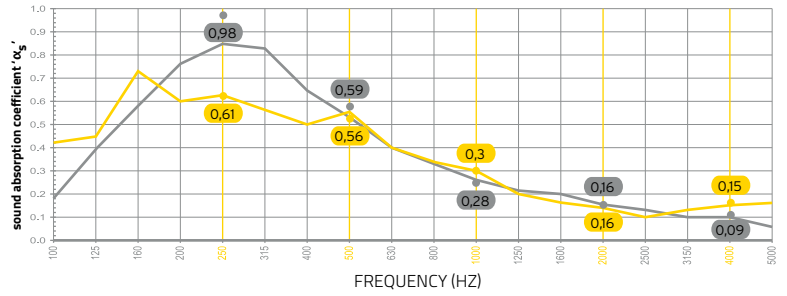

a = 16 mm
b = 17,5 mm
c = 17,5 mm
d = 16 mm

α_p 0,82 | 1,12 | 0,87 | 0,64 | 0,41 | $\alpha_w = 0,60$
0,88 | 0,91 | 0,84 | 0,63 | 0,46 | $\alpha_w = 0,65$

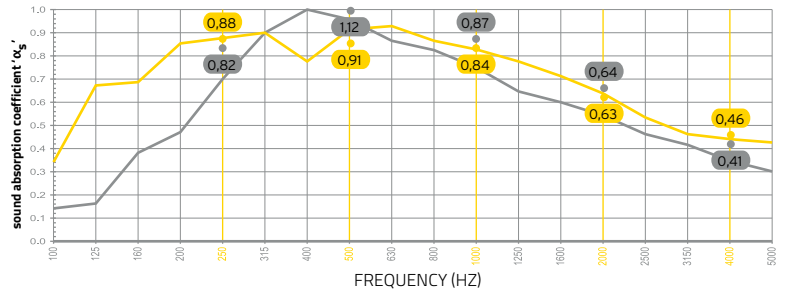

WOOD CEILINGS & COVERINGS: technical perfection, 100% made in Italy.

Modern, welcoming workplaces, free from noise pollution, where the warmth of natural wood is complemented by stylish, clean lines. Slats and panels set new standards in style for public offices and community spaces.

Modular elements standard or custom made, resistant, durable, easy to handle, simple and quick to install, inspected, certified, eco-friendly. They can be installed in any environment thanks to the architectural elements of great aesthetic versatility.



AESTETICH VERSATILITY

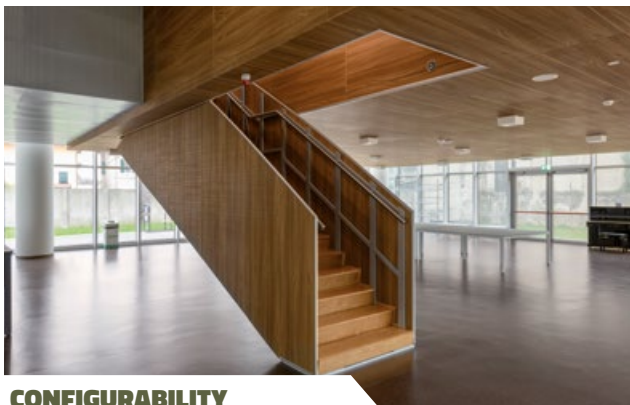

CONFIGURABILITY



HI-TECH PERFORMANCES

Why

- **MODERN AESTHETICS FOR ENVIRONMENTS WITH A WELCOMING AND NATURAL ATMOSPHERE.**
- **EXCLUSIVE IN-LINE ASSEMBLY STRUCTURE: SIMPLE, QUICK TO INSTALL, WITH CUSTOMIZABLE GAP ON REQUEST.**
- **SEISMIC SAFETY.**

Where

AUDITORIUMS, THEATRES, AIRPORTS, CONFERENCE ROOMS, OFFICES, PUBLIC SPACES AND ALL ENVIRONMENTS THAT REQUIRE SAFETY, EFFECTIVE NOISE CONTROL AND ELEGANT INTERIOR DESIGN.

Benefit

- **ACHIEVING FLEXIBLE, COMFORTABLE, CONTEMPORARY AND RESPONSIBLE INTERIORS.**
- **OBTAINING POINTS FOR LEED CERTIFICATION.**
- **SOUNDPROOFED ENVIRONMENTS.**
- **SPEEDING UP CONSTRUCTION.**
- **CONTAINING COSTS OF LABOUR AND MAINTENANCE.**
- **STRUCTURES 100% INSPECTABLE.**
- **INTEGRATION WITH ADVANCED CLIMATE CONTROL, DOMOTICS AND LIGHTING.**
- **PRECISE BUDGETING.**



FIRE REACTION

CBI Europe works hard to ensure the safety of the environments set up with its products. Research and tests allow us to obtain a constant evolution of quality. Certifications are provided on request.



FASTNESS

Our systems are designed to guarantee rapid installation, speeding up the laying phases and respecting all the requirements of planarity and orthogonality.



ACOUSTIC ABSORPTION

All systems are designed to offer excellent sound absorption performance, specific to the type of environment, safety and aesthetic results. Certifications are provided on request.



LEED CERTIFICATION

All products are manufactured in certified and constantly monitored processes to guarantee the highest standards of quality and safety.



ANTI-SEISMIC

The systems guarantee the application of all good safety practices in the construction and development of dedicated projects. Upon request, they can be supplied with an anti-seismic reports, which indicate suitable bracing.



INTEGRATED ACCESSORIES

The system can be fitted with accessories such as lighting units, ventilation vents, smoke detectors, sprinklers and suspended signage.



RECOMMENDATIONS FOR INSTALLATION

Slight differences in colour and shade between one panel and another are due to natural variations in the wood veneers. To obtain the most pleasing aesthetic effect, we recommend that you lay the panels out before deciding on their final arrangement. It is also good idea to order an extra number of panels to allow for future replacements, since shades, colours and grain can vary from one batch to another. All 'CBI Sound Wood Panels' must only be installed in indoor environments when the building maintained at a constant temperature.

Wood System panels should be removed from their packaging in the place of installation 48 hours before installing the ceiling or wall, so that they can assume the humidity of the environment. We recommend switching on the air conditioning in the environment at least 24 hours before starting installation. The installation environment should have temperature no lower than 15° and a relative humidity between 35% and 55% before work starts.



HYGIENE AND MAINTENANCE

Wood System panels are easy to maintain and require no special maintenance. To clean, simply wipe with a dry cloth. Panels should not be exposed to direct sunlight: like all natural materials, wood tends to change colour when exposed to UV rays. The polyacrylate treatment of the panels tends to reduce this effect. Remember that water and humidity will damage the veneering.



CBI EUROPE

Via Mons. A.O. Romero, 14 · 60027 Osimo (AN) Italy
T +39 071 71 08 688 · fax +39 071 71 08 63
info@cbi-europe.com · www.cbi-europe.com



S-P-02547 EPD®
environdec.com

